



rabalux[®]

New Products

Autumn 2024

CONTACT • ELÉRHETŐSÉGEINK • KONTAKT

CENTRE/KÖZPONT/ZENTRALE



Magyarország/Hungary

RÁBALUX HEAD OFFICE
RÁBALUX VILÁGÍTÁSTECHNIKA ZRT.
VILÁGÍTÁSTECHNIKA GYÁRTÁS ÉS FORGALMAZÁS/
LIGHTING PRODUCTION AND DISTRIBUTION

9027 Győr, Körtefa u. 5.
Tel.: +36 96 526 716
E-mail: info@rabalux.com
www.rabalux.com

AFFILIATES/LEÁNYVÁLLALATOK/ZWEIGSTELLEN



Bulgaria

РАБАЛУКС ЕООД / RABALUX EOOD
ул. "Андрей Николов" №15,
1111 София,
България
Тел./Факс: +359 2 936 00 97
E-mail: infobg@rabalux.com
www.rabalux.bg



Croatia, Bosnia Herzegovina, Montenegro



RABALUX RASVJETA d.o.o.
Ulica grada Gospića 1a
10000 Zagreb
Tel.: +385 1 652 80 66
E-mail: infocro@rabalux.com
www.rabalux.hr



Czech Republic

RABALUX CZ Světidla s.r.o.
Kaštanová 141/a, 617 00 Brno,
Česká Republika
Tel.: +420 739 665 322
E-mail: infocz@rabalux.com
www.rabalux.cz



Hungary

Rabalux Magyarország Kft.
Magyarország
9027 Győr,
Körtefa u. 5.
Tel.: +36 96 526 716
E-mail: infohu@rabalux.com
www.rabalux.hu



Lithuania, Latvia, Estonia



UAB „Rabalux Baltic“
Bičiulių g. 29,
LT-14182 Bukiškis,
Vilniaus r. Lietuva
Tel.: +370 6161 3066
E-mail: infobaltic@rabalux.com
www.rabalux.lt



Poland

Rabalux Sp. z o.o.
ul. Sołtysia 119, 40-750 Katowice,
Polska
Tel.: +48 32 254 61 34
E-mail: infopl@rabalux.com
zamowienia@rabalux.com
www.rabalux.pl



Romania

SC RABALUX SRL
Cluj-Napoca, str. Fabricii,
nr. 93-103, jud. CLUJ
Romania
cod postal: 400632
Tel.: +40 264 456 040
E-mail: info@rabalux.com
www.rabalux.ro



Serbia, Northern Macedonia



Rabalux SRB d.o.o.
Autoput br.20
11080 Beograd –
Zemun, Srbija
Mob: + 381 60 444 3977;
Tel.: +381(0)11 2013 986
E-mail: infosrb@rabalux.com
www.rabalux.rs



Slovakia

RABALUX SK. Svetidlá, s.r.o.
Alžbetínske nám. 328,
929 01 Dunajská Streda,
Slovenská Republika
Tel.: +421 31 551 54 04
E-mail: infosk@rabalux.com
www.rabalux.sk



Ukraine

ТОВ Рабалукс,
вул. Рилеева 4, м. Ужгород,
Україна, 88017
тел.: +38 0312 64 04 00,
моб.тел.: +38 067 310 05 20
E-mail: info@rabalux.com
www.rabalux.ua

OFFICIAL RESELLERS/MEGBÍZOTT VISZONTELADÓK/BEAUFTRAGTE WIEDERVERKÄUFER



Germany

Sinnocon GmbH
01156 Dresden,
Breitscheidstr. 45
Tel.: +49 351 65335641
E-mail: rabalux@sinnocon.de
www.sinnocon.de



Slovenia

Lagea d.o.o.
Brezina 19c
8250 Brežice
Republika Slovenija
Tel.: +386 70 292 70 20
E-mail: elmat@lagea.si



Greece

ANASTASIADI SA
1km Katerini-Ganohora Road,
Katerini, 60100
Tel.: +30 2351039757
E-mail: eshop@anastasiadi.gr
www.anastasiadi.gr



Greece

S.MELISSOURGOS CO OE
8 Kourtiou St,
11146 Galatsi,
Tel.: +0030 2102136040
E-mail: info@melissourgos.com.gr
melissourgos.com.gr



Portugal

STORM LIGHT,LDA
Rua António Pereira Vidal Xavier nº,
3750-802 Valongo do Vouga,
Tel.: 234 661 068
E-mail: geral@storm-light.pt
www.storm-light.pt



Spain

Buyled Led Lighting S.L
03007, Alicante,
ES, C/Gillen de Castro 1
Tel.: +34 654 870 866
E-mail: info@buyled.es
www.buyled.es



Italy

Fra.Co.Distribuzione Srl
Sp1 km24,
90047 Partinico (PA)
Tel.: 0039 0915071547
E-mail: info@fracodistribuzione.it
www.fracodistribuzione.it



Finland

Focus Interiors Oy
Kuusipolku 35,
37150 Nokia
Tel.: +358 (0)10 3270 520
E-mail: info@focusinteriors.fi
www.focusinteriors.fi



Qatar

GO GREEN INTERNATIONAL
TRADING W.L.L
New Salata, C Ring Road,
Sharq Capital Building-311 P.O Box 37372,
Doha, Qatar
Tel.: (+974) 4409 5443, (+974) 5552 9088
E-mail: sales@ggilighting.com
www.ggilighting.com



Albania

FAAM Light sh.p.k.
Rruga Muhedin Llagani,
Kompleksi Square 21,
Tirana, Albania
Tel.: +355 67 446 6888
E-mail: info@faamlight.al
www.faamlight.al



United Kingdom

Lighting Direct
24-26 Vincent Ave,
Crownhill, Milton Keynes
Buckinghamshire, MK8 0AB
E-mail: customerservice@lighting-direct.co.uk
www.lighting-direct.co.uk

CONTENTS • TARTALOMJEGYZÉK • INHALTSVERZEICHNIS

01

LED LAMPS

LED lámpák
LED-Lampen

8-25

02

LAMPS WITH SOCKETS

Foglaltos lámpák
Lampen mit Fassungen

26-39

03

OTHER PRODUCTS

Egyéb termékek
Andere Produkte

40-45

04

DATA
Adatok
Daten

46-51

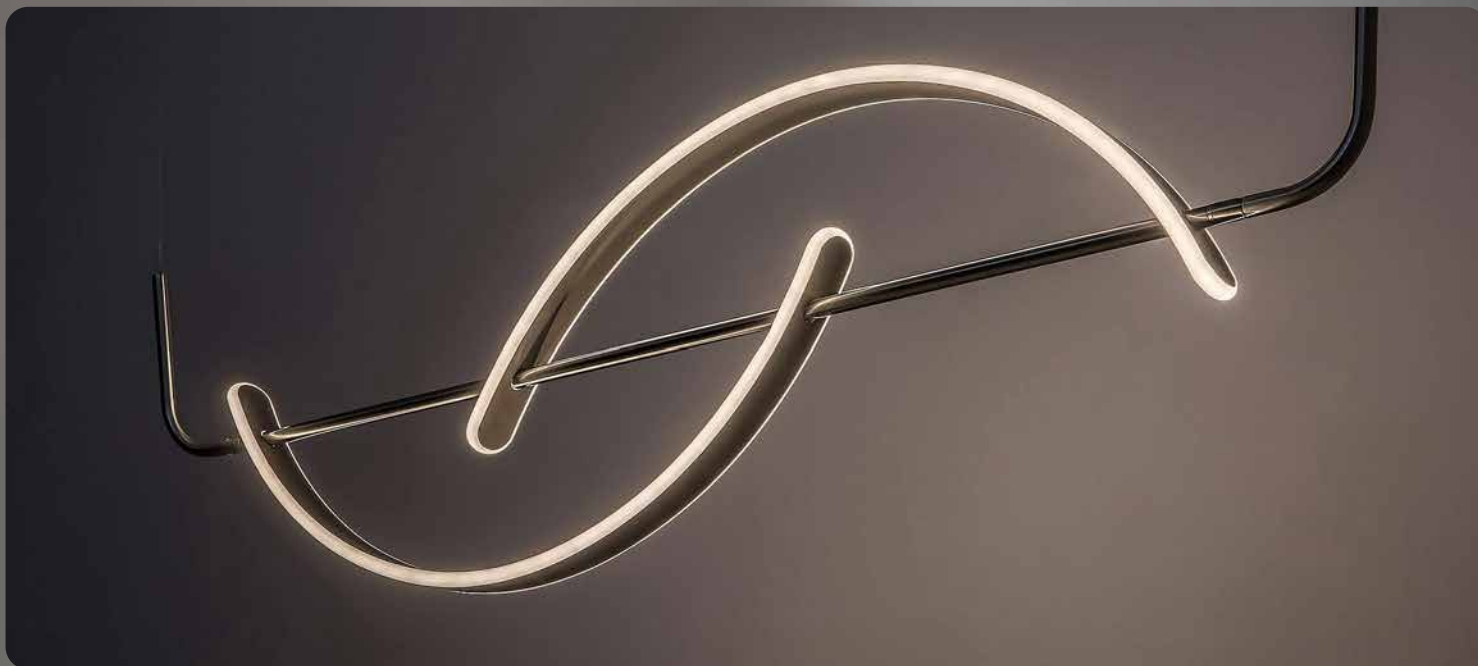

DESIGNED BY RABALUX



GERGŐ HORVÁTH

EN "I love designing lamps because it allows my creativity to unfold while creating functional and aesthetic objects that bring light and atmosphere into people's lives. Additionally, it's an exciting challenge to combine innovative technologies and materials in the design, finding new solutions for lighting."

HU "Azért szeretek lámpát tervezni, mert a kreativitásom kibontakozhat, miközben funkcionális és esztétikus tárgyakat hozok létre, amelyek fényt és hangulatot visznek az emberek életébe. Emellett izgalmas kihívás, hogy az innovatív technológiákat és anyagokat kombináljam a dizájnban, új megoldásokat találva a világításra."

DE "Ich liebe es Lampen zu entwerfen, weil meine Kreativität sich entfalten kann, während ich funktionale und ästhetische Objekte schaffe, die Licht und Atmosphäre in das Leben der Menschen bringen. Außerdem ist es eine spannende Herausforderung, innovative Technologien und Materialien im Design zu kombinieren und neue Lösungen für die Beleuchtung zu finden."

EN Meet our designer team who create our unique and special lamps. Their lamps are modern and exciting, they follow the latest trends and stand out from the existing Rabalux range. In addition to technological innovations, our experts also pay special attention to design, because nowadays lamps not only give light but also add style to our homes.

Discover our latest "Designed by Rabalux" collection, look for the label in our brochure!

HU Ismerje meg tervezőcsapatunkat, akiknek egyedi és különleges lámpáinkat köszönhetjük. Az általuk megálmodott világítótestek modernek és izgalmasak, követik az aktuális trendeket, ezáltal kiemelkednek a Rabalux meglévő kínálatából. Szakembereink a technológia újításokon túl a formatervezésre is kiemelt figyelmet fordítanak, hiszen ma már a lámpa nemcsak fényt, de stílust is ad otthonunknak.

Fedezze fel legújabb saját tervezésű lámpakollekciójukat, keresse a jelzést kiadványunkban!

DE Lernen Sie unser Designer Team kennen, die unsere einzigartigen und besonderen Lampen entwerfen. Ihre Lampen sind modern und aufregend, sie folgen den neuesten Trends und heben sich vom bestehenden Rabalux-Sortiment ab. Neben den technologischen Innovationen legen unsere Experten auch ein besonderes Augenmerk auf das Design, denn heutzutage geben Lampen nicht nur Licht, sondern auch Stil für unser Zuhause.

Entdecken Sie unsere neueste „Designed by Rabalux“ Kollektion, suchen Sie nach dem Logo in unserer Broschüre!



designed by
rabalux[®]

ANNAMÁRIA BÉKI-IBRÁNYI

EN "What is lamp design? Shapes, colours, lights, function. The design process can be intuitive or strategic. Intuition can come from an inspiration, an idea that has just come to mind. It can lead to interesting and innovative directions. Strategic design looks at the market need itself. In this case, the design is targeted. We move in the direction of a specific lamp based on specific requests. After the pleasure of planning, we look for the best design. When an idea turns into a product in the homes of customers, it is truly exhilarating."

HU "Mi is a lámpatervezés? Formák, színek, fények, funkció. A tervezés folyamata lehet intuíción és stratégiai. Az intuíció jöhet egy inspirációból, éppen felmerülő ötletből. Igazán érdekes, formabontó irányok születhetnek így. A stratégiai tervezés magát a piaci igényt veszi górcső alá. Ebben az esetben a tervezés célirányos. Egy konkrét lámpa irányába mozdulunk el meghatározott kéréseket figyelembe véve. A tervezés öröme után keressük a legjobb kivitelezést. Amikor egy ötletből a vásárlók otthonába kerül egy termék, az igazán felemelő."

DE "Was ist Lampendesign? Formen, Farben, Licht, Funktion. Der Designprozess kann intuitiv oder strategisch sein. Die Intuition kann einer Inspiration entspringen, einer Idee, die einem gerade in den Sinn gekommen ist. Sie kann zu interessanten und innovativen Richtungen führen. Strategisches Design befasst sich mit dem Marktbedarf selbst. In diesem Fall ist das Design zielgerichtet. Wir bewegen uns in Richtung einer bestimmten Leuchte auf der Grundlage spezifischer Anforderungen. Nach der Freude an der Planung suchen wir nach dem besten Design. Wenn sich eine Idee in ein Produkt verwandelt, das bei den Kunden zu Hause steht, ist das wirklich aufregend."

SZABOLCS MÁJ

EN "The reason for my love of lamp design is that the process requires multifaceted knowledge. Every step is important, from the initial idea to the technical details, and finally, the ultimate design. As a result of thorough work, lamps with unique designs can be born, which can become the jewels of our homes, like carefully selected furniture. These principles guided me when designing the new **Sindri** family, and we jointly developed it to meet the needs of most households.

This lamp family features a modern, minimalist design characterized by clean lines and geometric shapes. The materials used are primarily metal and LED light sources, ensuring energy-efficient and long-lasting lighting. The colour palette is mostly neutral, such as black, white, and metallic shades, which easily fit into various interior spaces. Overall, this lamp family is the perfect choice for those seeking a modern, energy-efficient, and elegant lighting solution for their home or office."

HU "Lámpatervezés iránti szeretetem oka, hogy ez a folyamat sokrétű tudást igényel. Az ötlettől a technikai részletekig, egészen a végső kialakításig minden lépés fontos. Az alapos munka eredményeképpen egyedül designnal rendelkező lámpák születhetnek, amelyek lakásunk égböve lehetnek, hasonlóan a kiválasztott bútorokhoz. Ezek az elvek vezéreltek, amikor az új **Sindri** családot terveztem, és közösen alakítottuk ki úgy, hogy megfeleljen a legtöbb háztartás igényeinek.

Ez a lámpacsalád modern, minimalista dizájnnal rendelkezik, amelyet a letisztult vonalak és a geometriai formák jellemeznek. Az anyaghasználat főként fémből és LED fényforrásokból áll, amelyek biztosítják az energiatakarékos és hosszú élettartamú világítást. A színpaletta többnyire neutrális, mint a fekete, fehér és fémes árnyalatok, amelyek könnyen illeszkednek a különböző belső terekhez. Összességében ez a lámpacsalád tökéletes választás azoknak, akik modern, energiatakarékos és elegáns világítási megoldást keresnek otthonuk vagy irodájuk számára."

DE "Der Grund für meine Liebe zum Lampendesign ist, dass der Prozess facettenreiches Wissen erfordert. Jeder Schritt ist wichtig, von der ersten Idee über die technischen Details bis hin zum endgültigen Design. Als Ergebnis gründlicher Arbeit können einzigartige Lampendesigns entstehen, die zu den Schmuckstücken unserer Häuser werden können, ähnlich wie sorgfältig ausgewählte Möbel. Diese Prinzipien leiteten mich beim Entwurf der neuen Familie **Sindri**, die wir gemeinsam entwickelten, um den Bedürfnissen der meisten Haushalte gerecht zu werden.

Diese Lampenfamilie zeichnet sich durch ein modernes, minimalistisches Design aus, das durch klare Linien und geometrische Formen geprägt ist. Die verwendeten Materialien sind hauptsächlich Metall und LED-Lichtquellen, die eine energieeffiziente und langlebige Beleuchtung gewährleisten. Die Farbpalette ist überwiegend neutral, wie Schwarz, Weiß und metallische Töne, die sich leicht in verschiedene Innenräume einfügen. Insgesamt ist diese Lampenfamilie die perfekte Wahl für diejenigen, die eine moderne, energieeffiziente und elegante Beleuchtungslösung für ihr Zuhause oder Büro suchen."

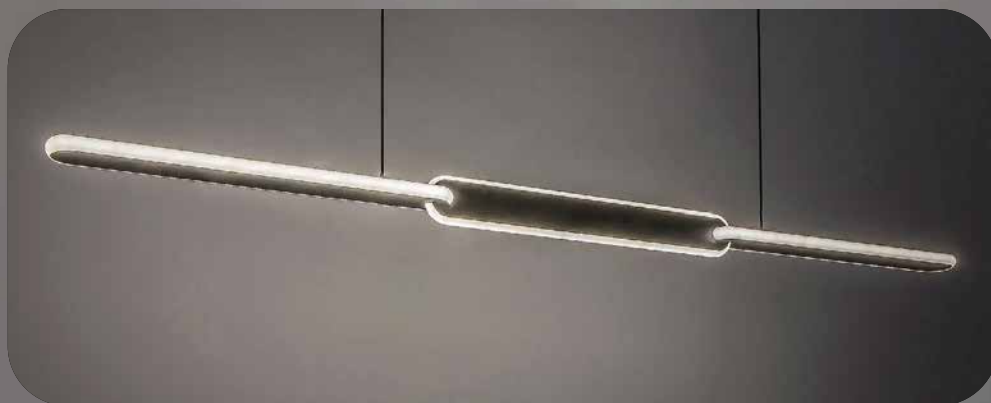

OVERVIEW



ELVIO
72234
9



JARNELLE
71088
10



JARNELLE
74196
10



JARNELLE
74197
10



JARNELLE
72233
11



JARNELLE
71052
11



SINDRI
72229
12



SINDRI
72231
12



SINDRI
71049
14



SINDRI
71050
14



SINDRI
71051
14



SINDRI
71087
15



SINDRI
74194
15



SINDRI
74195
15



MONTEMA
72191
16



FORMAND
71297
19



FORMAND
72297
19



ISAURE
71302
20



ISAURE
72301
20



ISAURE
72302
20



EMILION
71296
21



EMILION
72296
21



THRIC
71309
22



THRIC
71310
22

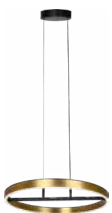

THRAC
72221
22



THRAC
71311
23



THRAC
71312
23



THRAC
72222
23



THRAC
72223
23



MATHIOLA
71290
24



MATHIOLA
71291
24



HOLIZE
71287
24



HOLIZE
71288
24



DEWSON
71289
25



ROSEHIP
72303
27

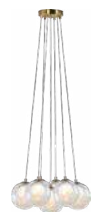

ROSEHIP
72304
27

OVERVIEW



ASLOV
71300
28



ASLOV
72298
28



ASLOV
71298
29



ASLOV
71299
29



SARABI
71301
30



MEDUZA
71294
31



MEDUZA
72194
31



LITON
72299
32



LITON
72300
32



ROVIER
72263
33

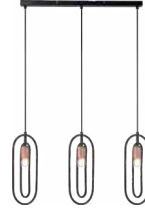

ROVIER
72264
33



NARMIN
72251
34

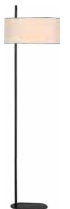

NARMIN
74240
34



NARMIN
74241
34



REVAN
71248
35



REVAN
72150
35



REVAN
74212
35



LOOPLAB
71295
36



AZOME
71293
37



COLZAR
75021
39



COLZAR
75022
39



GELLO
71285
41



GELLO
71286
41



TRAZE
74213
42



CERIE
74232
42



CERIE
74233
42



BEDI
74234
43



BEDI
74235
43



BEDI
74236
43



BEDI
74237
43



TAFI
74238
43



ZAVIER
74214
44



TIPY
74209
44



CUBIKO
76022
45



JOCKER
76023
45



OI

LED LAMPS

LED LÁMPÁK

LED-LAMPEN

ELVIO



72234

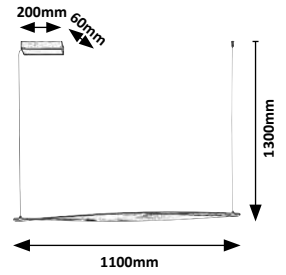

72234 **M P**

LED / 28W
(2150lm, 3800lm;
3000K) incl. • IP20
satin chrome/white



5 996595 722340

JARNELLE



71088

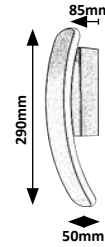

74196

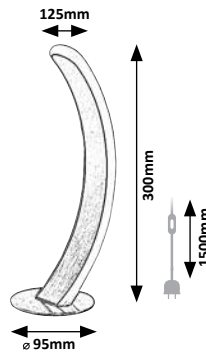

74197

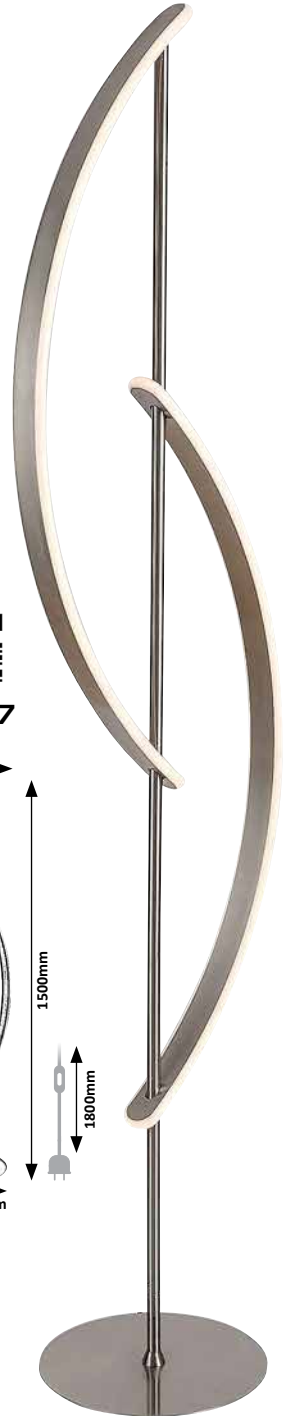
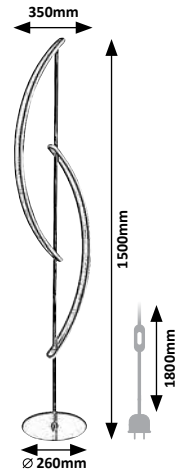

71088 (M) (P)

LED / 12W
 (800lm, 1400lm;
 3000K) incl. • IP20
 satin chrome/white



5 996595 710880

74196 (M) (P)

LED / 12W
 (850lm, 1400lm;
 3000K) incl. • IP20 • •
 satin chrome/white



5 996595 741969

74197 (M) (P)

LED / 30W
 (2000lm, 4000lm;
 3000K) incl. • IP20 • •
 satin chrome/white



5 996595 741976

JARNELLE

5 YEARS GUARANTEE

LED built-in

WARM White

G A+G

designed by **rabalux**

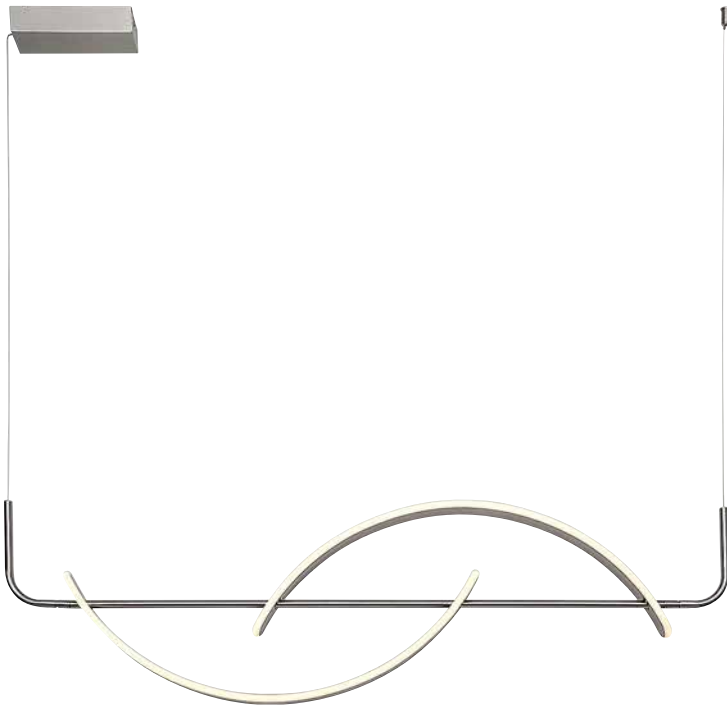

72233

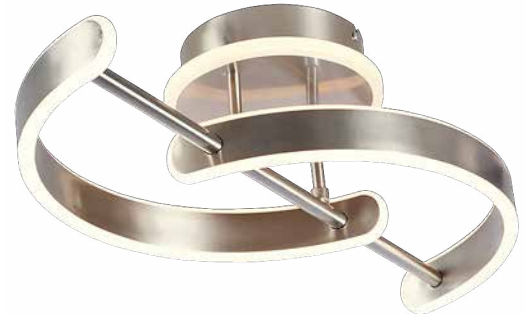
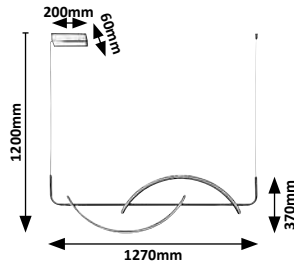

71052

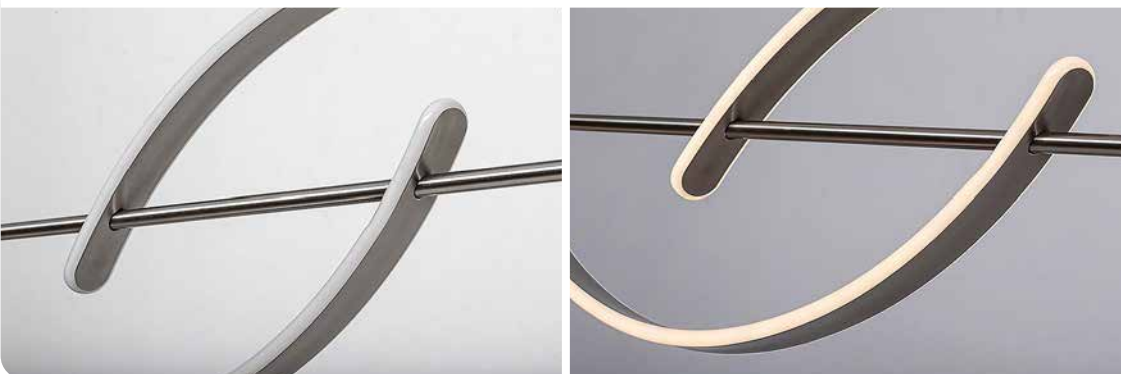
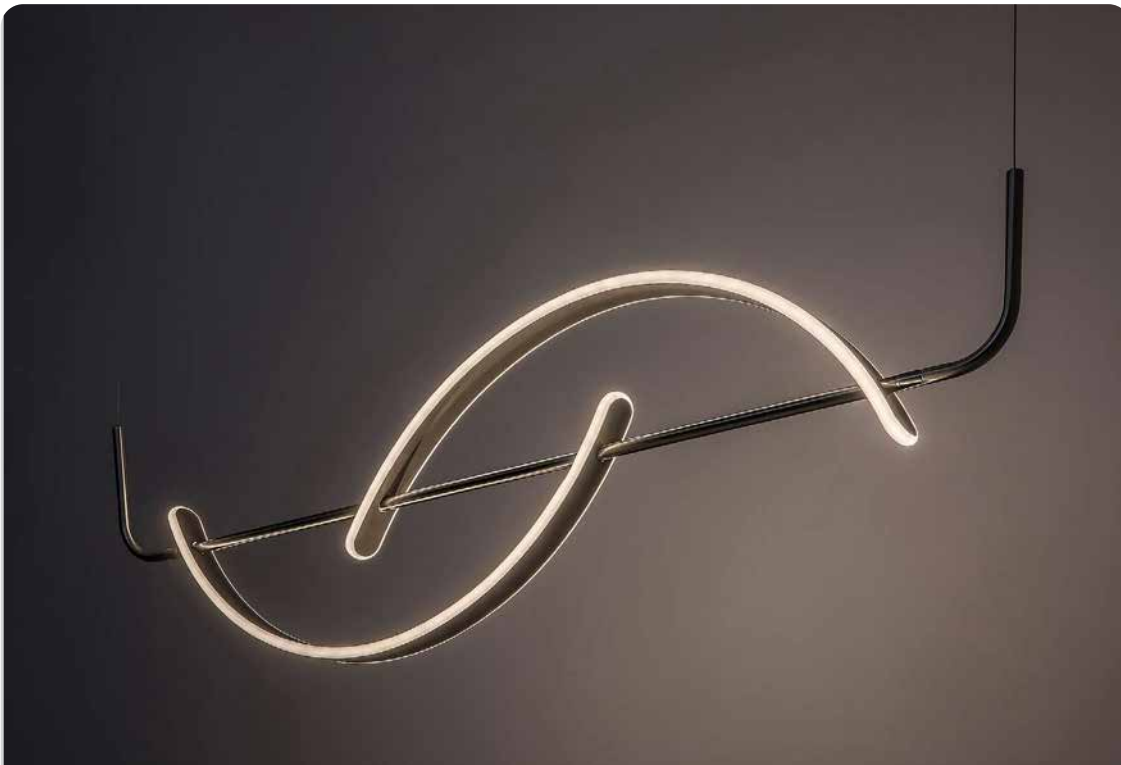
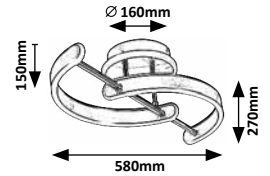

72233

(M) (P)

LED / 35W
 (2450lm, 4800lm;
 3000K) incl. • IP20
 satin chrome/white



5 996595 722333

71052

(M) (P)

LED / 30W
 (2150lm, 3800lm;
 3000K) incl. • IP20
 satin chrome/white



5 996595 710521



SINDRI



72229

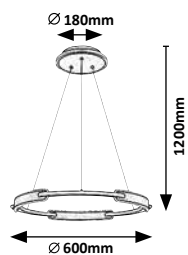

72231

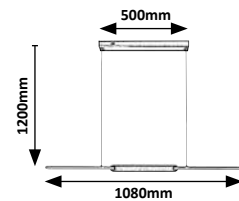

72229 (M) (P)

LED / 45W
 (3200lm, 5200lm;
 3000K-4000K) incl. • IP20
 black/white



5 996595 722296

72231 (M) (P)

LED / 36W
 (2050lm, 4000lm;
 3000K-4000K) incl. • IP20
 black/white



5 996595 722319





SINDRI



71051

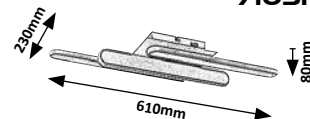

71050

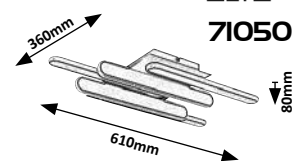

71049

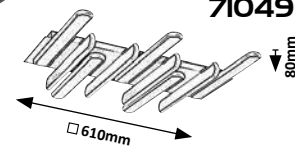

71049 (M) (P)

LED / 46W
 (2500lm, 5400lm;
 3000K-4000K) incl. • IP20
 black/white



5 996595 710491

71050 (M) (P)

LED / 36W
 (1900lm, 4200lm;
 3000K-4000K) incl. • IP20
 black/white



5 996595 710507

71051 (M) (P)

LED / 18W
 (950lm, 2100lm;
 3000K-4000K) incl. • IP20
 black/white



5 996595 710514

SINDRI



71087

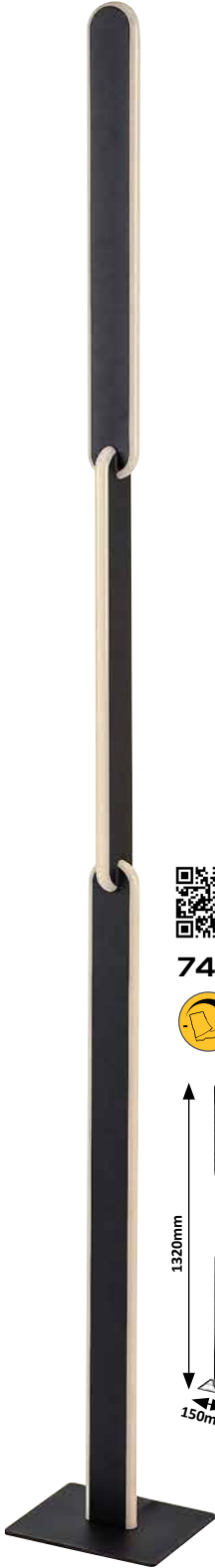
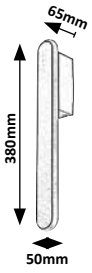

74195

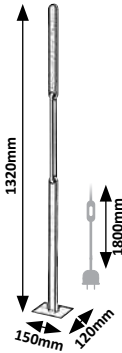

74194

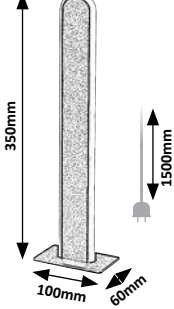

71087 (M) (P)

LED / 12W
 (750lm, 1400lm;
 3000K-4000K) incl. • IP20
 black/white



5 996595 710873

74194 (M) (P)

LED / 15W
 (750lm, 1500lm;
 3000K-4000K) incl. • IP20 •
 black/white



5 996595 741945

74195 (M) (P)

LED / 33W
 (1800lm, 3600lm;
 3000K-4000K) incl. • IP20 •
 black/white



5 996595 741952

MONTEMA

5
YEAR
WARRANTY

LED
built-in

NATURAL
White

G
A
↑
G



72191

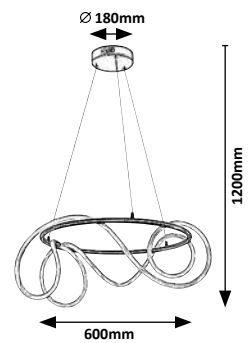

72191 (M SI)

LED / 54W
(4480lm, 5130lm;
4000K) incl. • IP20
black/white



5 996595 721916

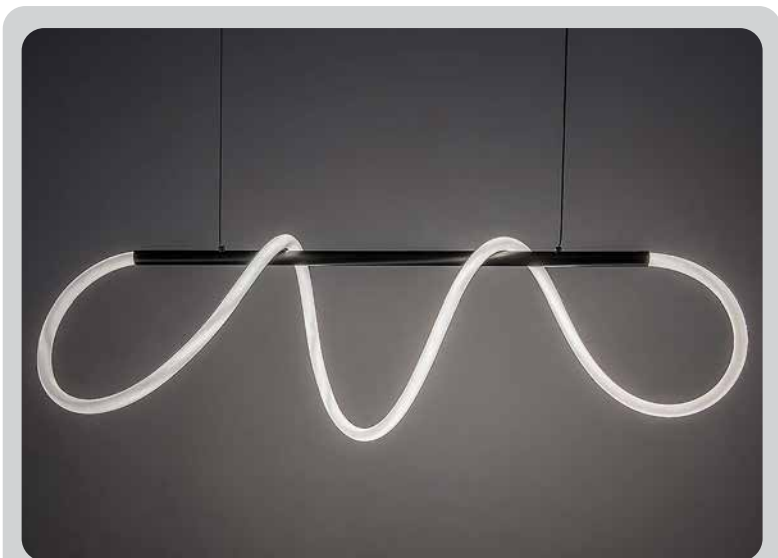

EN Look at the other family member.
Item number: 72269

HU Nézd meg a másik családtagot.
Cikkszám: 72269

DE Schau dir das andere Familienmitglied an.
Artikelnummer: 72269





FORMAND

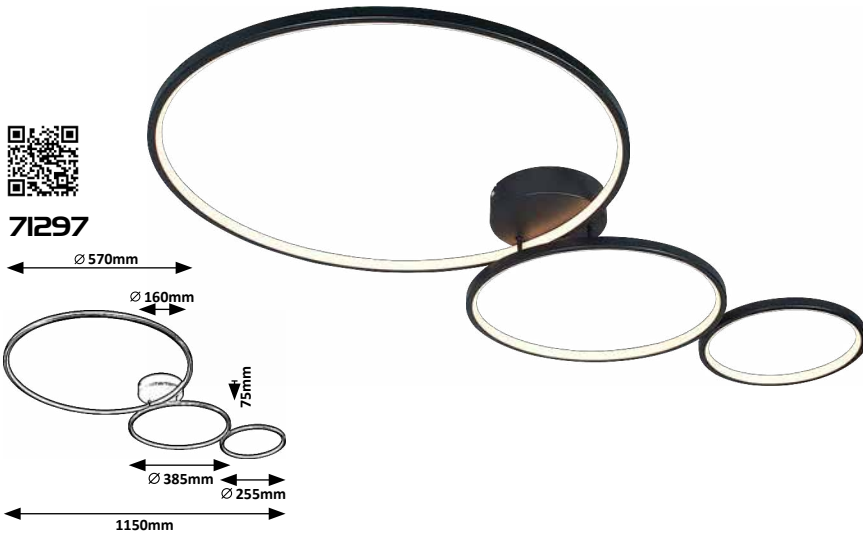

71297



72297

71297 (M) (P)

LED / 38W
 (1100lm, 4500lm;
 3000K) incl. • IP20
 black/white



5 996595 712976

72297 (M) (P)

LED / 38W
 (1100lm, 4500lm;
 3000K) incl. • IP20
 black/white



5 996595 722975

ISAURE



71302

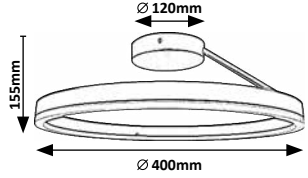

72301

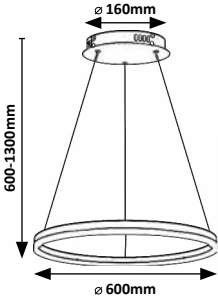

72302

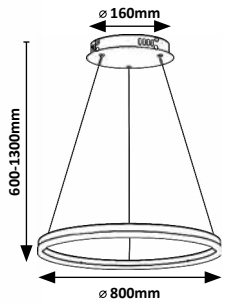

71302 (M) (A)

LED / 24W
 (1600lm, 2040lm;
 3000K-4000K-6500K) incl. • IP20
 black/white



5 996595 713027

72301 (M) (A)

LED / 35W
 (2200lm, 3060lm;
 3000K-4000K-6500K) incl. • IP20
 black/white



5 996595 723019

72302 (M) (A)

LED / 45W
 (3000lm, 4250lm;
 3000K-4000K-6500K) incl. • IP20
 black/white



5 996595 723026

EMILION



71296

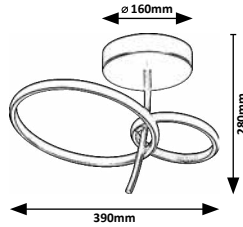

72296

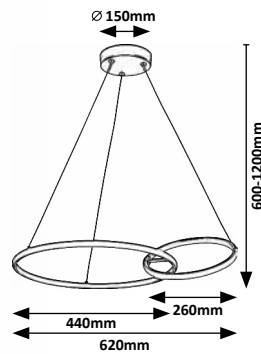

71296 (M SI)

LED / 24W
 (1450lm, 2280lm;
 4000K) incl. • IP20
 black/gold/white



5 996595 712969

72296 (M SI)

LED / 36W
 (2150lm, 3420lm;
 4000K) incl. • IP20
 black/gold/white



5 996595 722968



THRIC



71309

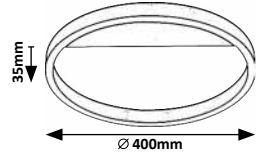

71310

30mm



72221

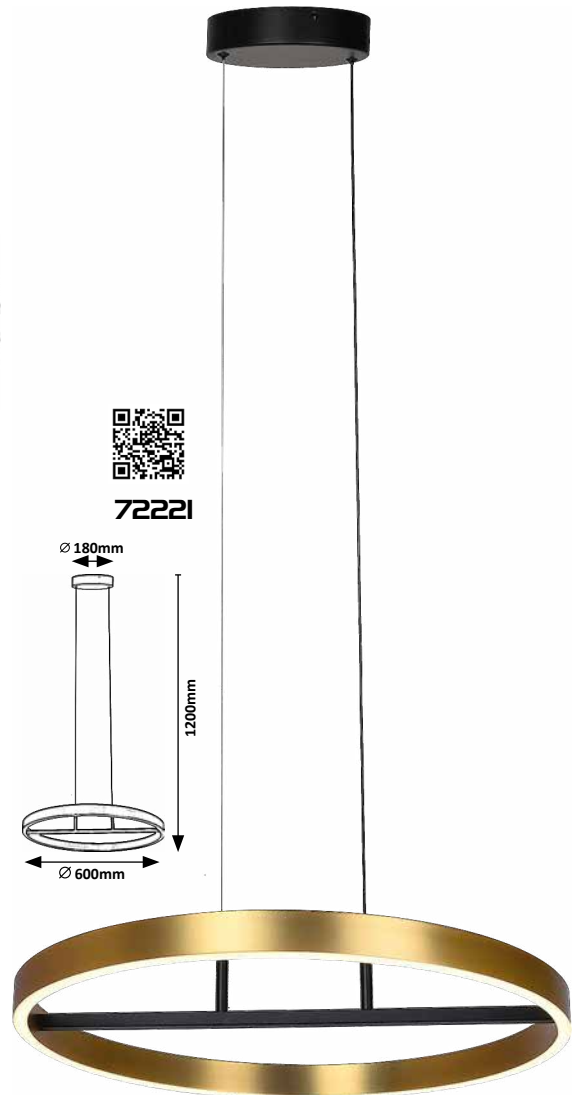

71309 (M) (SI)

LED / 20W
 (1250lm, 1950lm;
 3000K) incl. • IP20
 black/gold/white



71310 (M) (SI)

LED / 15W
 (960lm, 1650lm;
 3000K) incl. • IP20
 black/gold/white



72221 (M) (SI)

LED / 42W
 (3500lm, 4970lm;
 3000K) incl. • IP20
 black/gold/white



THRAC



7131I

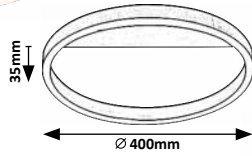

71312

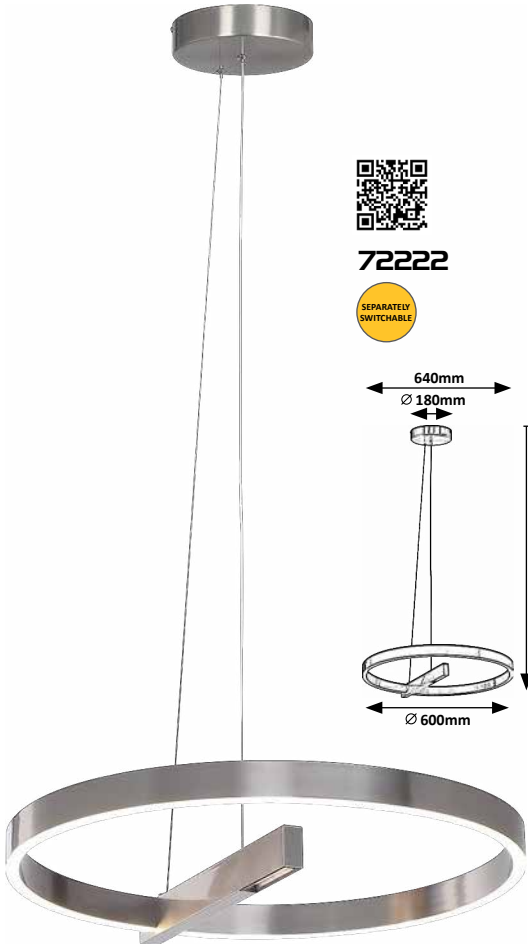

72222

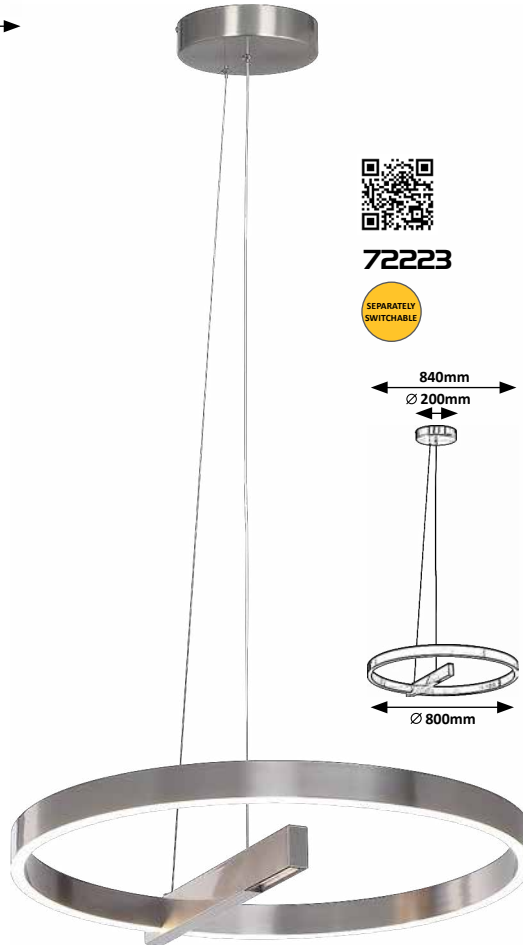
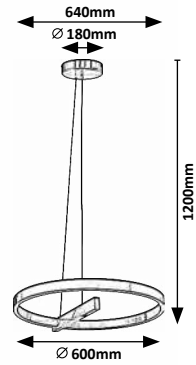

72223

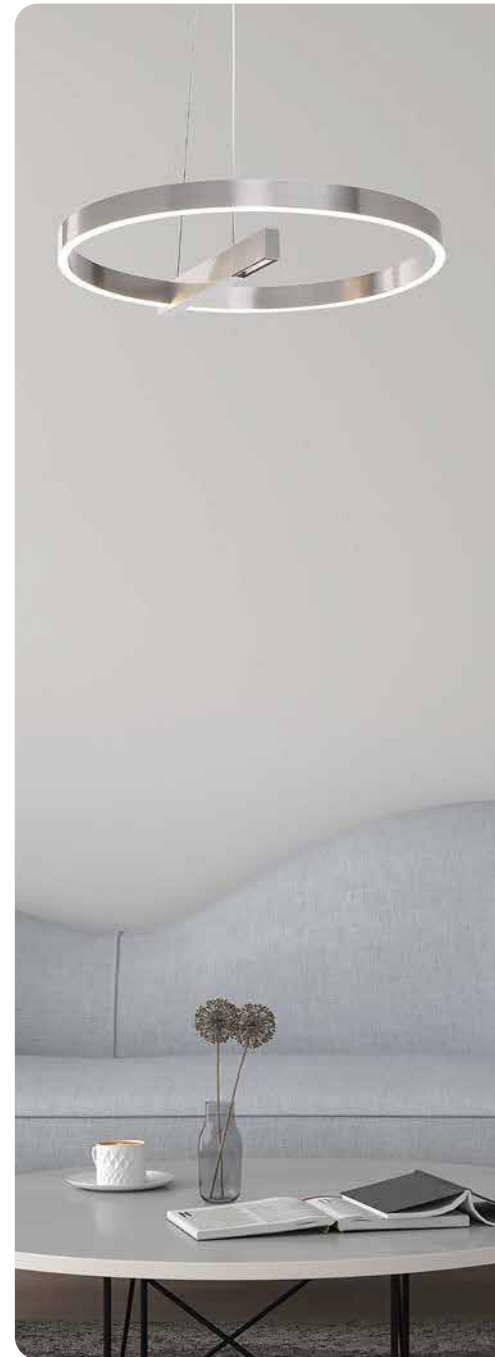
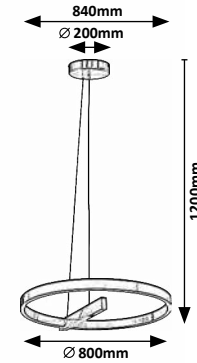

7131I (M SI)

LED / 20W
 (1350lm, 2090lm;
 4000K) incl. • IP20
 brushed aluminium/white



5 996595 713119

71312 (M SI)

LED / 15W
 (1000lm, 1770lm;
 4000K) incl. • IP20
 brushed aluminium/white



5 996595 713126

72222 (M SI)

LED / 34W
 (1700lm, 2550lm;
 4000K) incl. • IP20
 brushed aluminium/white



5 996595 722227

72223 (M SI)

LED / 40W
 (2070lm, 3350lm;
 4000K) incl. • IP20
 brushed aluminium/white



5 996595 722234

MATHIOLA



71290

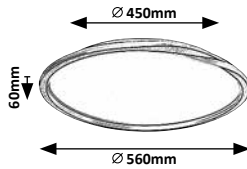

71291

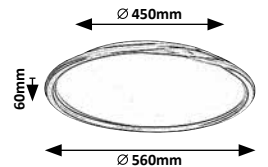

HOLIZE

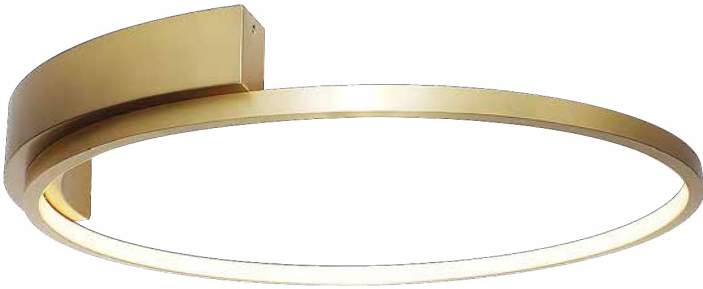

71287

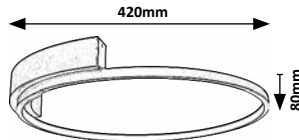

71288

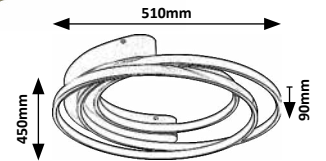

71290 (M P)

LED / 40W
 (2200lm, 4700lm;
 4000K) incl. • IP20
 black/white



5 996595 712907

71291 (M P)

LED / 40W
 (2450lm, 4500lm;
 3000K) incl. • IP20
 gold/white



5 996595 712914

71287 (M SI)

LED / 23W
 (1350lm, 2800lm;
 4000K) incl. • IP20
 gold/white



5 996595 712877

71288 (M SI)

LED / 50W
 (3400lm, 6200lm;
 4000K) incl. • IP20
 gold/white



5 996595 712884

DEWSON



71289

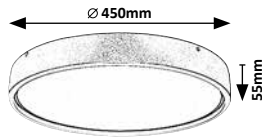

71289 (M) (P)

LED / 37W
(2480lm, 4400lm;
3000K) incl. • IP20
brushed aluminium/white



5 996595 712891





02

LAMPS WITH SOCKETS

FOGLALATOS LÁMPÁK

LAMPEN MIT FASSUNGEN

ROSEHIP

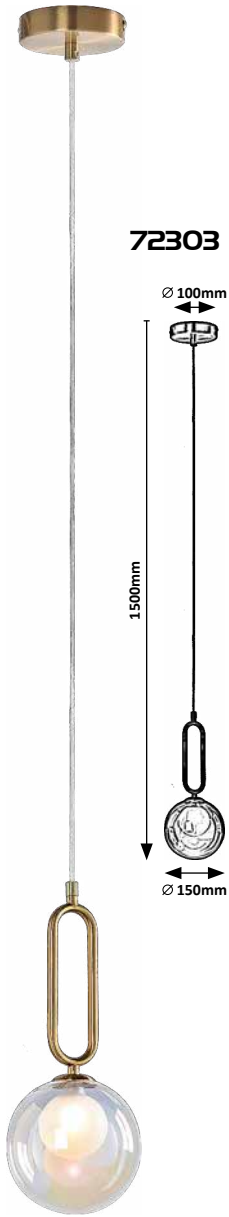
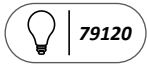

72303

Ø 100mm

1500mm

Ø 150mm

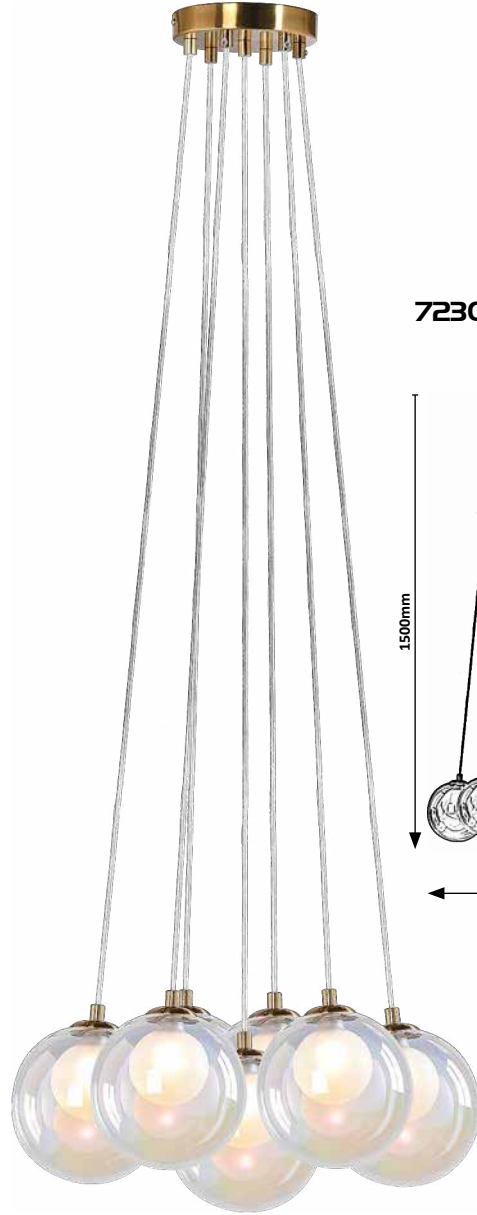

72304

Ø 150mm

1500mm

Ø 150mm

Ø 450mm



72303 **MG**

☒ G9 / 1x max. 25W
IP20 • 20164
champagne/multicolor



5 996595 723033

72304 **MG**

☒ G9 / 7x max. 25W
IP20 • 20164
champagne/multicolor



5 996595 723040

ASLOV

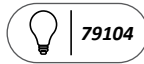

71300

72298

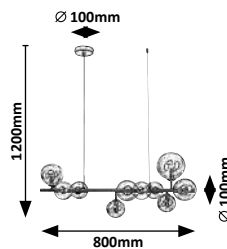

71300 **MG**

☒ G9 / 11x max. 28W
IP20
☑ 20057, 20058, 20059
gold/transparent



5 996595 713003

72298 **MG**

☒ G9 / 10x max. 28W
IP20
☑ 20057, 20058, 20059
gold/transparent



5 996595 722982

ASLOV

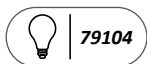

71298

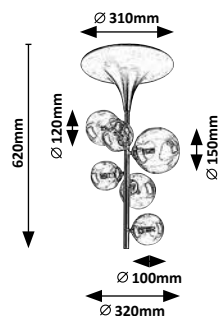

71299

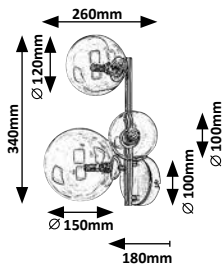

71298 **MG**

☒ G9 / 6x max. 28W
IP20
▣ 20057, 20058, 20059
gold/transparent



5 996595 712983

71299 **MG**

☒ G9 / 3x max. 28W
IP20
▣ 20057, 20058, 20059
gold/transparent



5 996595 712990



SARABI



71301

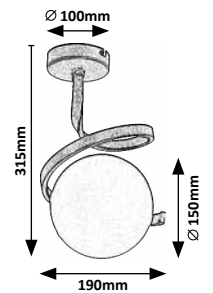

EN Look at the other family member.
Item number: 71136, 72126

HU Nézd meg a másik családtagot.
Cikkszám: 71136, 72126

DE Schau dir das andere Familienmitglied an.
Artikelnummer: 71136, 72126

71301 **MG**

☒ E27 / 1x max. 20W
IP20 • 20026
gold/white



MEDUZA

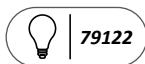

71294

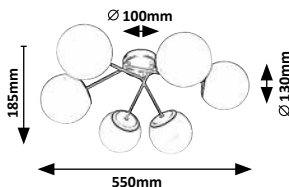

72194

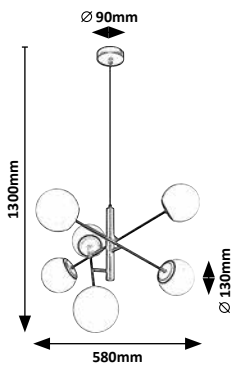

71294 **MG**

☒ E14 / 6x max. 20W
IP20 • 20161
matte black/white



5 996595 712945

72194 **MG**

☒ E14 / 6x max. 20W
IP20 • 20161
matte black/white



5 996595 721947





LITION

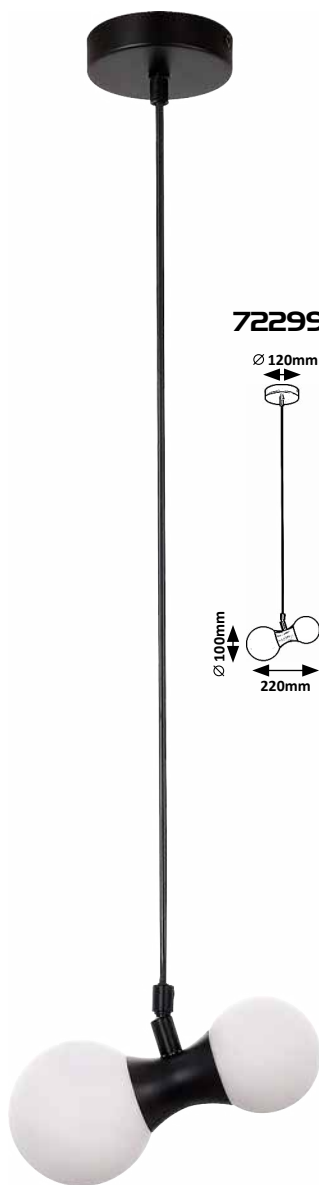
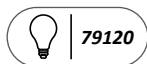

72299 **MG**

☒ G9 / 2x max. 28W
IP20
▣ 20162, 20163
black/white



72300 **MG**

☒ G9 / 6x max. 28W
IP20
▣ 20162, 20163
black/white



ROVIER



72263

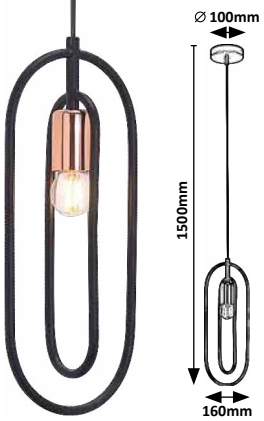

72264

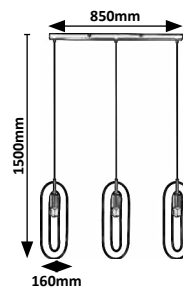

72263



☒ E27 / 1x max. 40W
IP20
matte black/copper



5 996595 722630

72264



☒ E27 / 3x max. 40W
IP20
matte black/copper



5 996595 722647



NARMIN

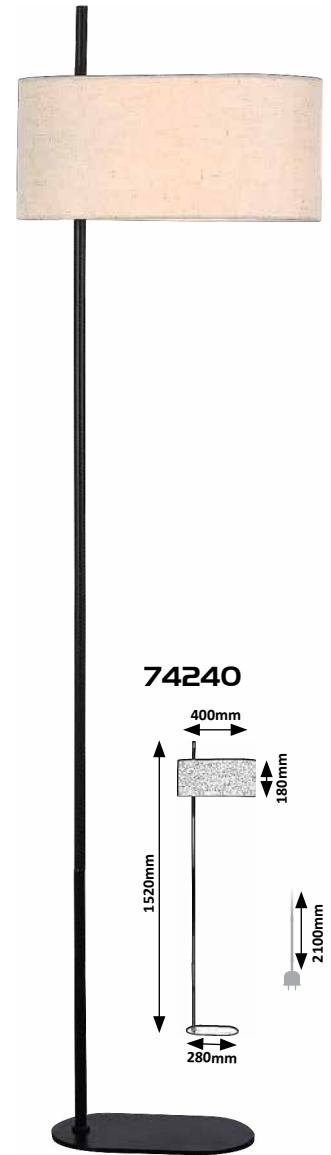
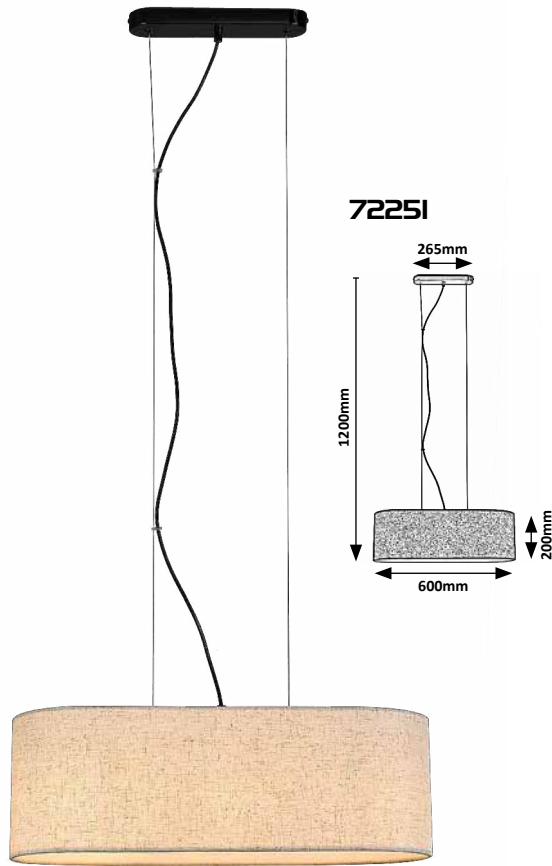
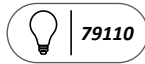

72251 **MT**

☒ E27 / 3x max. 40W
IP20
matte black/beige



5 996595 722517

74240 **MT**

☒ E27 / 1x max. 40W
IP20 • ☒
matte black/beige



5 996595 742409

74241 **MT**

☒ E14 / 1x max. 40W
IP20 • ☒
matte black/beige



5 996595 742416

REVAN

TEXTILE
BAND

1382



71248

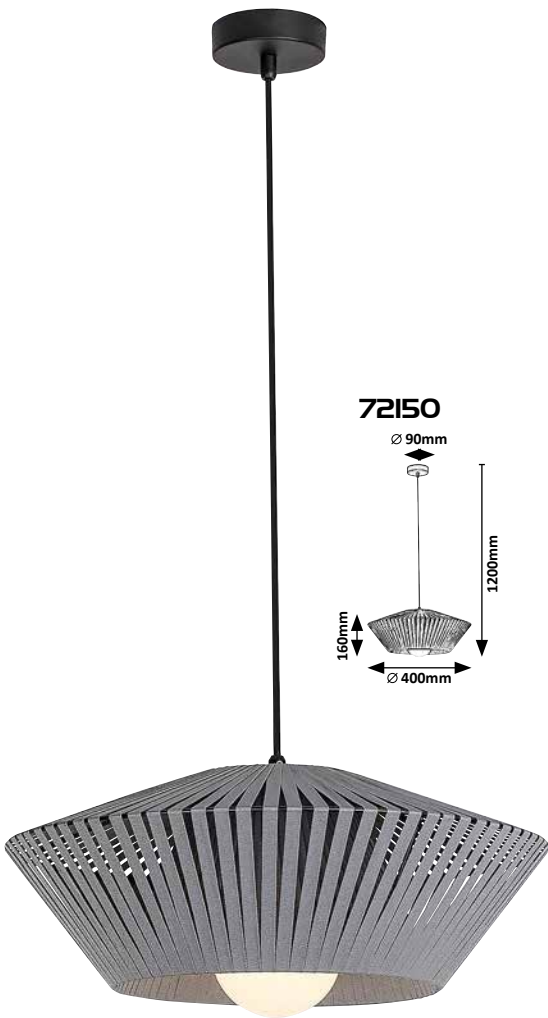
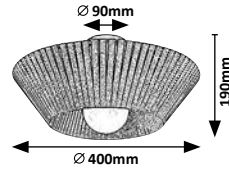

72150

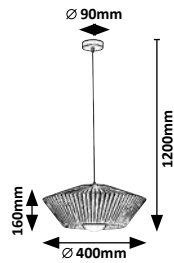

74212

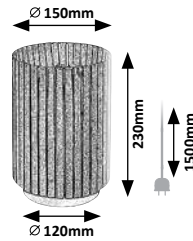

71248 (M) (T)

☒ E27 / 1x max. 6W
IP20
black/grey



72150 (M) (T)

☒ E27 / 1x max. 6W
IP20
black/grey



74212 (M) (T)

☒ E27 / 1x max. 6W
IP20 • ☐
black/grey



LOOPLAB

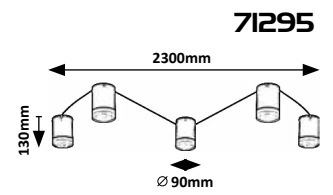
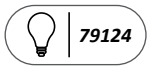

71295



☒ G9 / 5x max. 28W
IP20
black/transparent



5 996595 712952

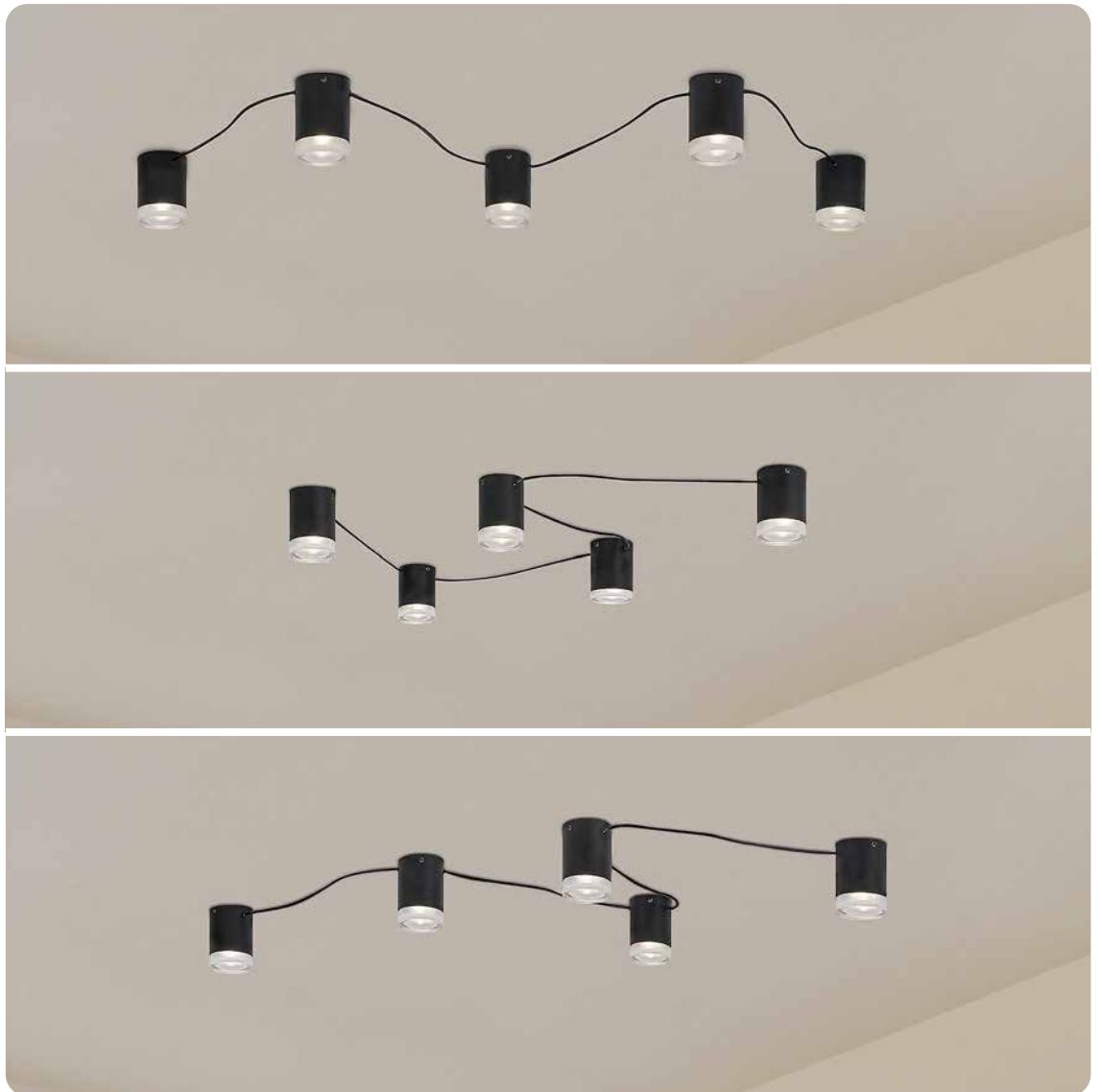

AZOME

WOOD



1658



71293

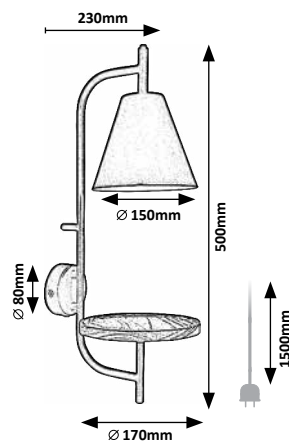

71293 MW

☒ E27 / 1x max. 15W
IP20 • 
beech/matte black





COLZAR



75021

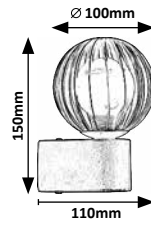

75022

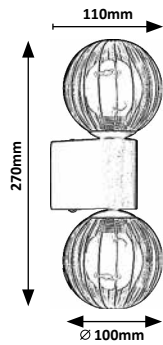

75021 **MG**

☒ G9 / 1x max. 3,5W
IP44 • 20158
matte black/milky/transparent



5 996595 750213

75022 **MG**

☒ G9 / 2x max. 3,5W
IP44 • 20158
matte black/milky/transparent



5 996595 750220

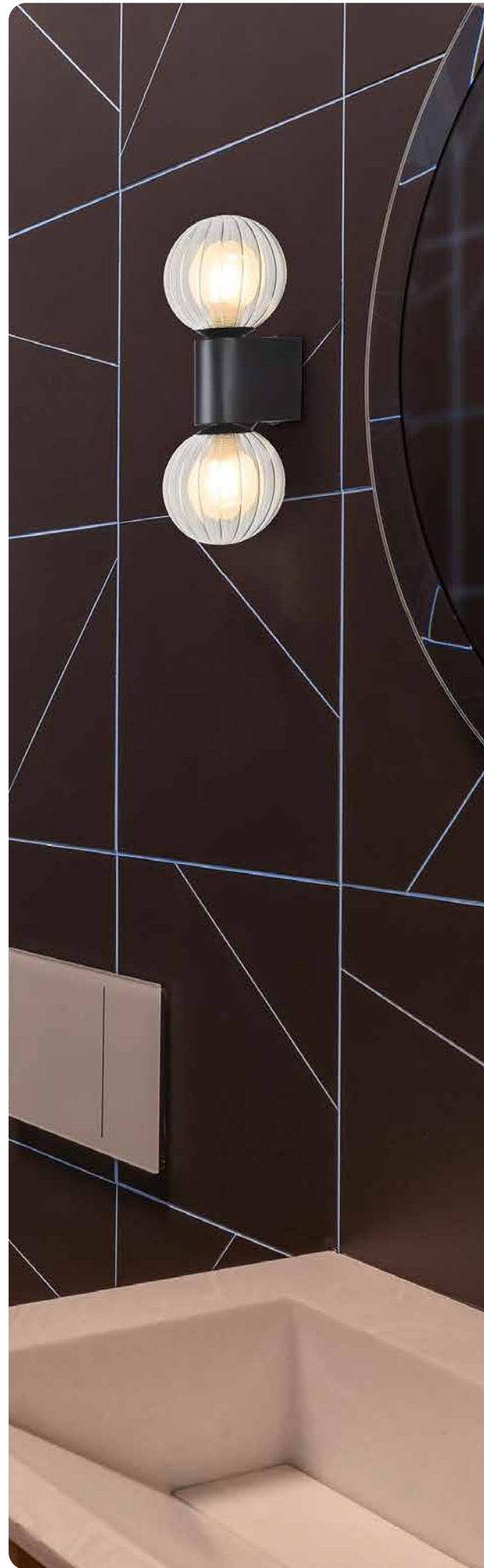



03

OTHER PRODUCTS

EGYÉB TERMÉKEK

ANDERE PRODUKTE

GELLO



71285

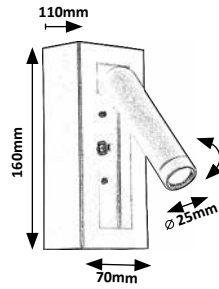

71286

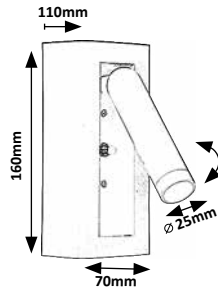

71285 (M P)

LED / 4W
(210lm, 260lm;
3000K) incl. • IP20 •
black



5 996595 712853

71286 (M P)

LED / 4W
(220lm, 260lm;
3000K) incl. • IP20 •
white



5 996595 712860

TRAZE



74213

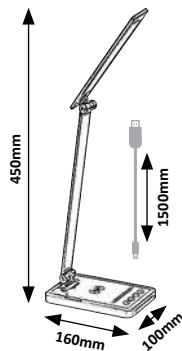

74213 (M) (P)

DC 5V / LED / 5W
 (190lm, 560lm;
 3000K-6500K) incl. • IP20
 black/white



5 996595 742133

CERIE



74232

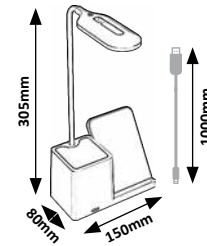

74233

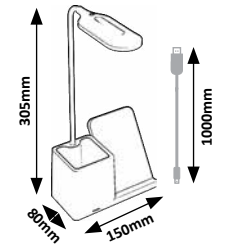

74233 (P)

DC 5V / LED / 4W
 (200lm, 320lm;
 3000K, 4000K, 6500K) incl. • IP20
 white



5 996595 742331

BEDI



TAFI

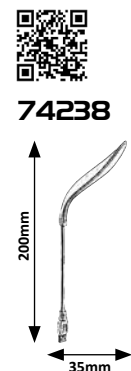

74234

(P)

☑ DC 5V / LED / 2W
 (☑165lm, ☑180lm;
 4000K) incl. • IP20
 white



5 996595 742348

74235

(P)

☑ DC 5V / LED / 2W
 (☑165lm, ☑180lm;
 4000K) incl. • IP20
 blue



5 996595 742355

74236

(P)

☑ DC 5V / LED / 2W
 (☑165lm, ☑180lm;
 4000K) incl. • IP20
 pink



5 996595 742362

74237

(P)

☑ DC 5V / LED / 2W
 (☑165lm, ☑180lm;
 4000K) incl. • IP20
 green



5 996595 742379

74238

(P)

☑ DC 5V / LED / 2W
 (☑165lm, ☑180lm;
 4000K) incl. • IP20
 white



5 996595 742386



ZAVIER



74214

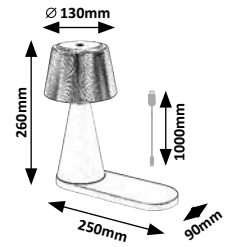

TIPY



74209

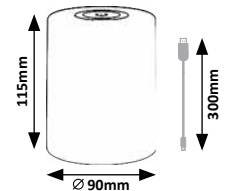

74214 P

☑ DC 5V / LED / 5W
 (☑220lm, ☑350lm;
 3000K, 4000K, 5000K) incl. • IP20
 5V 3600mAh incl. • white



5 996595 742140

74209 P

☑ DC 5V / 0,8W
 (☑50lm, ☑55lm;
 3000K) incl. • IP20
 3,7V 1800mAh incl. • white



5 996595 742096

CUBIKO



76022

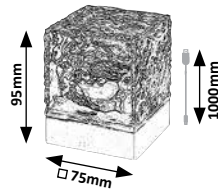

JOCKER



76023

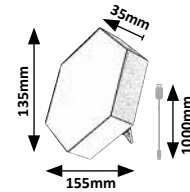

76023



76022



DC 5V / 1W
IP20
3XAA excl. • 547
white/transparent



5 996595 760229

76023



DC 5V / 1W
IP20
3XAA excl. • 550
black/transparent



5 996595 760236

KEY OF SYMBOLS • JELMAGYARÁZAT • ZEICHENERKLÄRUNG



	Symbols	Jelölések	Bezeichnungen	Symboles	Jména	Označenia	Oznaczenia	Позначення
	designed by Rabalux	Rábalux saját design	entworfen von Rabalux	conçu par Rabalux	Rabalux vlastní design	Rabalux vlastný dizajn	Zaprojektowano przez Rabalux	розроблений Rabalux
	Lightsource recommendation	Fényforrás ajánló	Lichtquellenempfehlung	Recommandation de source lumineuse	Doporučený světelný zdroj	Odporúčanie svetelného zdroja	Rekomendowane źródło światła	Рекомендація щодо джерела світла
	5 years guarantee	5 év garancia	5 Jahre Garantie	5 ans de garantie	záruka 5 let	Záruka 5 rokov	5-letnia gwarancja	гарантія 5 років
	built-in LED	beépített LED	LED inklusive	LED inclus	obsahuje LED	obsahuje LED diódy	Dioda LED w wyposażeniu	містить світлодіоди
	warm white light	meleg fehér fényű	warmweiß	blanc chaud	teplá bílá	teplá biela	ciepła biała	теплий білий
	natural white light	természetes fehér fényű	naturweiß	blanc naturel	přirozená bílá	prírodná biela	naturalna biała	натуральний білий
	colour temperature variable with switch	kapcsolóval állítható színhőmérséklet	mit Schalter einstellbare Farbtemperatur	température de couleur réglable avec interrupteur	spínačem nastaviteľná teplota chromatičnosti	možnosť nastavenia teploty farieb spínačom	temperatura barwy regulowana wyłącznikiem	колірна температура, регульована перемикачем
	colour temperature variable with touch switch	érintőkapcsolóval állítható színhőmérséklet	Mit Berührungsschalter einstellbare Farbtemperatur	température de couleur variable avec interrupteur tactile	změna teploty barvy světla pomocí dotykového spínače	nastavitelná farebná teplota s dotykovým spínačom	Regulacja temperatury światła za pomocą włącznika dotykowego	Колір світла змінюється доторканням
	Color temperature can be adjusted in three steps with a touch switch	Érintőkapcsolóval három lépésben szabályozható színhőmérséklet	Die Farbtemperatur kann in drei Stufen mit einem Touch-Schalter eingestellt werden	La température de couleur peut être ajustée en trois étapes avec un interrupteur tactile	Teplotu barev lze upravit ve třech krocích dotykovým spínačem	Teplotu farby je možné nastaviť v troch krokoch pomocou dotykového spínača	Temperaturę barwową można regulować w trzech krokach za pomocą przełącznika dotykowego	Колірну температуру можна регулювати в три етапи за допомогою сенсорного перемикача
	color temperature adjustable with foot switch	lábkapcsolóval állítható színhőmérséklet	Farbtemperatur mit Fußschalter einstellbar	température de couleur réglable avec interrupteur au pied	nastavitelná teplota barev pomocí nožního spínače	nastavitelná farebná teplota pomocou nožného spínača	regulowana temperatura barwowa za pomocą przełącznika nożnego	регульована колірна температура з ножним перемикачем
	Color temperature can be adjusted in 3 steps with a DIP switch	DIP kapcsolóval 3 lépésben szabályozható színhőmérséklet	Die Farbtemperatur kann mit einem DIP Schalter in 3 Stufen eingestellt werden	La température de couleur peut être ajustée en 3 étapes avec un interrupteur DIP	Teplotu barev lze nastavit pomocí DIP přepínače ve 3 krocích	Farebnú teplotu je možné nastaviť v 3 krokoch pomocou prepínača DIP	Temperaturę barwową można regulować w 3 krokach za pomocą przełącznika DIP	Колірну температуру можна регулювати в 3 кроки за допомогою DIP-перемикача
	with switch	kapcsolóval	mit Schalter	avec commutateur	se spínačem	so spínačom	z włącznikiem	із перемикачем
	touch switch dimmer	érintőkapcsolóval szabályozható fényerő	Touchbutton-Lichtstärkereglер	réglage de la luminosité avec interrupteur tactile	nastavení jasu dotykovým spínačem	dotykový spínač na reguláciu intenzity svetla	ściemniacz dotykowy	сенсорний диммер
	dimmable with switch	szabályozható fényerő kapcsolóval	Lichtstärke Regler mit Schalter	Regleur d'intensité de la lumière avec commutateur	regulátor jasu se spínačem	regulátor jasu so spínačom	regulator natężenia światła z włącznikiem	регулятор потужності світла із перемикачем

KEY OF SYMBOLS • JELMAGYARÁZAT • ZEICHENERKLÄRUNG



	Simboluri	Označavanje	Oznake	Oznake	Символи	Simboliai	Simboli	Sümbolid
	designed de Rabalux	Rabalux dizajn	dizajnirao Rablux	zasnoval Rabalux	проектирано от Rabalux	suprojektavo „Rabalux“	izstrādājis Rabalux	Rabaluxi disain
	Recomandare sursa de lumina	preporuka za tip sijalice	Preporuka izvora svjetla	Odporúčanie svetelného zdroja	Препоръка за източник на светлина	Šviesos šaltinio rekomendacija	leteikums par gaismas avotu	Valgusallika soovitus
	5 ani garanție	5 godina garancije	5 godina jamstva	5 let garancije	5 години гаранция	5 metų garantija	5 gadu garantija	5-aastane garantii
	LED încorporat	ugrađeni LED	ugrađeni LED	vgrajen LED	вграден LED	įmontuotas LED įrenginys	ieübvēta LED	sisse-ehitatud LED
	alb cald	toplo bela	toplo bijelo	toplo bela	топло бяло	šiltai balta	silti balts	soe valge
	alb natural	prirodno bela	prirodno bijelo	naravno bela	естествено бяло	natūraliai balta	dabīgi balts	loomulik valge
	temperatura culorii controlată cu comutator	temperatura boja može da se podesi sa prekidačem	temperatura boja se može podesiti s prekidačem	barvna temperatura nastavljiva s stikalom	регулируема с ключ светлинна температура	jungikliu keičiama spalvos temperatūra	ar slēdzi maināma krāsu temperatūra	lūlitiga reguleeritav vārvitemperatuur
	temperatura variabilă a culorii cu comutator tactil	Temperatura svetla, podesiva putem prekidača na dodir	Temperatura boje podesiva prekidačem na dodir	sprememba barvne temperature s stikalom na dotik	промянана на цветната температура с докосване	Prilietimu keičiama spalvos temperatūra	Krāsu temperatūras mainīgais ar skārienkrānu	puutelūlitist muudetav vārvitemperatuur
	Temperatura culorii poate fi ajustată în trei pași cu un comutator tactil	Temperatura boje se može podesiti u tri koraka pomoću dodirnog prekidača	Temperatura boje može se podesiti u tri koraka pomoću prekidača na dodir	Barvno temperaturo lahko nastavite v treh korakih s stikalom na dotik	Цветовата температура може да се регулира на три стъпки с сензорен превключвател	Spalvos temperatūrą galima reguliuoti trimis žingsniais jutikliniu jungikliu	Krāsu temperatūru var regulēt trīs soļos ar skārienslēdzi	Vārvitemperatuuri saab puutelūlitiga kolmes astmes reguleerida
	temperatura de culoare reglabilă cu comutator de picior	temperatura boje se podešava nožnim prekidačem	podesiva temperatura boje s nožnim prekidačem	nastavljiva barvna temperatura z nožnim stikalom	регулируема цветна температура с педал	reguliuojama spalvos temperatūra su kojiniu jungikliu	regulējama krāsas temperatūra ar kājas slēdzi	jalglūlitiga reguleeritav vārvitemperatuur
	Temperatura de culoare poate fi reglată în 3 trepte cu un comutator DIP	Temperatura boje se može podesiti u 3 koraka pomoću DIP prekidača	Temperatura boje može se podesiti u 3 koraka pomoću DIP prekidača	Barvno temperaturo lahko nastavite v 3 korakih s DIP stikalom	Цветовата температура може да се регулира на 3 стъпки с DIP превключвател	Spalvos temperatūrą galima reguliuoti 3 žingsniais DIP jungikliu	Krāsu temperatūru var regulēt 3 soļos ar DIP slēdzi	Vārvitemperatuuri saab DIP-lūlitiga reguleerida 3 astmes
	cu întrerupător	sa prekidačem	s prekidačem	s stikalom	с превключвател	su jungikliu	ar slēdzi	lūlitiga
	senzor tactil pentru reglarea luminozității	podešavanje jačine svetlosti sa prekidačem na dodir	podešavanje svjetline pomoću dodirne sklopke	Prilagodite svetlost z stikalom na dotik	регулатор на яркостта със сензорен превключвател	liečiamasis pritemdymo jutiklis	skārienjutīgs gaismmaiņa slēdzis	puutetundlik valgusregulaator
	regulator intensitate lumina cu întrerupător	regulator svetlosti sa prekidačem	regulator jače svjetla s prekidačem	zatemnilnik s stikalom	с регулатор за силата на светлина с превключвател	pritemdymo įtaisas su jungikliu	gaismmains ar slēdzi	hāmardi lūlitiga

KEY OF SYMBOLS • JELMAGYARÁZAT • ZEICHENERKLÄRUNG



GBR



HUN



GER



FRA



CZE



SVK



POL



UKR

	Symbols	Jelölések	Bezeichnungen	Symboles	Jména	Označenia	Oznaczenia	Позначення
	adjustable brightness with foot switch	szabályozható fényerő lábkapcsolóval	dimmbarer Helligkeit mit Fußschalter	luminosité réglable avec interrupteur à pied	nastavitelný jas s nožním spínačem	nastavitelný jas s nožným spínačom	regulowane światło z przełącznikiem nożnym	регульована яскравість з ножним перемикачем
	light intensity variable only with remote control	csak távirányítóval állítható fényerő	Lichtintensität nur mit Fernbedienung einstellbar	intensité lumineuse variable uniquement avec télécommande	intenzitu světla lze nastavit pouze pomocí dálkového ovládání	možnosť nastavenia intenzity svetla iba s diaľkovým ovládačom	natężenie światła regulowane tylko przy pomocy pilota	інтенсивність світла регулюється тільки за допомогою пульту
	RGB colour change LED	RGB színváltós LED	Farbwechsel-LED	LED à changement de couleurs	LED diody střídající barvu	LED s meniacou sa farbou	Zmieniający kolor LED	Світлодіоди зі зміною кольору
	IP protection	IP védettség	IP-Klasse	protection IP	IP krytí	IP ochrana	Stopień ochrony IP	Клас IP-захисту
	textil band	textil szalagok	Textilband	bande textile	textilní páska	textilný pás	taśma tekstylna	текстильна стрічка
	wood	fa	Holz	bois	dřevo	Drevo	Drewno	дерево
	separately switchable lightsources	fényforrások külön kapcsolhatóak	Lichtquellen sind extra schaltbar	sources lumineuses changeable séparément	samostatně přepínatelné	samostatne prepínateľné	Możliwość zastosowania podwójnego wyłącznika	Джерела світла перемикаються окремо
	sound reactive	hangra aktiválódó	schallreaktiv	réactif au son	reagující na zvuk	reagující na zvuk	reagujący na dźwięk	звуково-реактивний
	timer function	időzítő funkció	mit einer Zeitfunktion	avec fonction de temps	s časovačem	s časovačom	z funkcją timera	з функцією таймера
	night light function	éjszakai funkció	Nachtfunktion	fonction nuit	funkce nočního světla	funkcia nočného svetla	Funkcja światła nocnego	функція нічника
	memory function	memória funkció	Speicherfunktion	fonction mémoire	funkce pamět	funkcia pamäte	Funkcja pamięci	функція пам'яті
	wireless charger	vezeték nélküli töltő	kabelloses Ladegerät	chargeur sans fil	bezdrátová nabíječka	bezdrôtová nabijačka	ładowarka bezprzewodowa	бездротовий зарядний пристрій
	micro-USB included	micro-USB tartozék	Micro-USB Zubehör	Avec Micro USB livré	Micro-USB v příslušenství	Príslušenstvo Micro-USB	Micro-USB w zestawie	Містить мікро-USB
	battery included	elemet tartalmaz	inklusive Batterie	pile incluse	součástí balení je baterie	súčasťou balenia je batéria	Bateria w zestawie	батарея додається

KEY OF SYMBOLS • JELMAGYARÁZAT • ZEICHENERKLÄRUNG



	Simboluri	Označavanje	Oznake	Oznake	Символи	Simboliai	Simboli	Sümbolid
	luminozitate reglabilă cu comutator de pocior	podesiva osvetljenost sa nožnim prekidačem	podesiva svjetlina s nožnim prekidačem	nastavljiva svetlost s stopalko	регулируема яркост с крачен превключател	reguliuojamas ryškumas su kojiniu jungikliu	regulējams spilgtums ar kājas slēdzi	reguleeritav heledusega jalglülitiga
	Intensitate variabilă a luminii numai de la telecomandă	Intenzitet svetlosti podesiv samo uz pomoć daljinskog upravljača	jačina svjetla promjenjiva samo sa daljinskim upravljačem	možnost nastavitve jakosti svetlobe samo z daljinskim upravljanjem	димирание само чрез дистанционно управление	tik šviesos stiprio kintamasis su nuotolinio valdymo pultu	gaismas intensitāte mainīga tikai ar tālvadības pultī	valguse intensiivsust saab reguleerida ainult kaugjuhtimispuldi abil
	LED RGB	LED sa promenljivim bojama	LED s promjenjivim bojama	LED diode s spremenljivim barvama	LED с променлива светлина	Spalvą keičiantis LED	Maināmas krāsas LED	Värvi vahetav LED
	Protecția IP	IP zaščita	IP zaščita	IP zaščita	с IP защита	IP klasė	IP aizsardzība	IP kaitse
	bandă textilă	tekstilna traka	tekstilna traka	tekstilni trak	текстилна лента	tekstilinė juosta	tekstilmateriāla lente	tekstiilpael
	lemn	drven	drvo	les	дърво	medis	koksne	puit
	comutabil separat	Odvojeno paljenje	Izvori svjetlosti se mogu uključiti odvojeno	ločen preklop virov svetlobe	Отделно превключване	Atskirai perjungiamas	Atsevišķi pārslēdzams	eraldi lülitatavad valgusallikad
	reactiv la sunet	reaguje na zvuk	zvučno-reaktivan	zvočno reaktiven	реагиращ на звук	reaguojantis į garsą	reaģējošs uz skaņu	helile reageeriv
	cu temporizator	sa vremenskom funkcijom	s vremenskom funkcijom	s časovno funkcijo	с функция за време	su laiko funkcija	ar laika funkciju	ajafunktsiooniga
	Funcție lumina de noapte	funkcija nočno svetlo	funkcija nočnog svjetla	nočna funkcija	функция нощна светлина	naktinio apšvietimo funkcija	nakts apgaismojuma funkcija	õine funktsioon
	Funcție de memorie	funkcija pamćenja	funkcija memorije	pomnilna funkcija	функция памет	atminties funkcija	atmiņas funkcija	mālu funktsioon
	incărcător wireless	bežični punjač	bežični punjač	brežični polnilec	безжично зарядно устройство	belaidis įkroviklis	bezvadu lādētājs	juhtmeta laadija
	Accesoriu Micro-USB	Mikro-USB dodatna oprema	Mikro USB pribor	Mikro USB-pripomoček	С принадлежност Micro-USB	Priedama „Micro-USB“	Micro-USB iekļauts komplektā	Mikro-USB komplektis
	baterija este inclusă	baterija u opremi	baterija je uključena	baterije so vključene	предоставена батерия	su baterija	baterija ietilpst komplektā	patarei kuulub komplekti

COLOURS • SZÍNEK • FARBEN



beech	bükk	Buche	hêtre	buk	buk	buk	бук
beige	bézs	Beige	beige	Bežová	běžová	Beżowy	беж
black	fekete	Schwarz	noir	černá	čierna	czarny	чорний
brushed aluminium	súrolt alumínium	gebürstetes Aluminium	aluminium brossé	broušený hliník	kartáčovaný hliník	szczotkowane aluminium	полірований алюміній
champagne	pezsgő	Champagner	champagne	šampaňská barva	šampanská farba	szampański	колір шампанського
copper	réz	Kupfer	cuivre	měděná	medená	miedz	мідь
gold	arany	Gold	dorée	zlatá	zlatá	złoty	золотий
grey	szürke	Grau	gris	šedá	šedá	popielaty	сірий
matte black	matt fekete	Mattschwarz	noir mat	matná černá	matná čierna	czarny matowy	матово-чорний
milky	tejes	milchig	laiteux	mléčný	mlečný	mleczny	молочний
multicolour	többszínű	Multicolor	multicolore	vícebarevná	viacfarebná	wielokolorowy	багатокольоровий
pink	rózsaszín	rosa	rose	růžový	ružový	różowy	рожевий
satin chrome	szatin króm	Satin-Chromfarbig	chrome satiné	hedvábně lesklá chromová	saténová chrómová	chrom satyna	сатиново хромовий
transparent	átlátszó	transparent	transparent	průhledná	priehľadná	przezroczysty	прозорий
white	fehér	Weiss	blanc	bílá	biela	biały	білий



fag	bukva	bukva	bukev	бук	buko	dižskābardis	põök
bej	bež	bež	bež	бежов	smėlio	bėšs	beež
negru	crno	crno	črno	черен	juoda	melns	must
aluminiiu šlefuit	brušeni aluminijum	strugani aluminij	brušen aluminij	драскан алуминий	braižyto aliuminio	matēts alumīnijs	harjatud alumiinium
culoarea sampanie	boja šampanjca	boja šampanjca	barva šampanjca	шампанско	šampano	šampanieša krāsa	šampanja
cupru	bakren	bakren	baker	медна	vario	varš	vask
auriu	zlatno	zlatno	zlatno	златен	auksinė	zelta	kuldne
gri	sivo	sivo	sivo	сив	pilka	pelēks	hall
mat negru	mat crno	mat crno	mat črno	мат-черен	matinė juoda	matēti melns	matt must
lāptos	mlečan	mliječni	mlečen	млечен	pieniškās	pienains	piimjas
multicolor	višebojno	višebojno	večbarvno	многоцветен	įvairiaspalvė	daudzkrāsains	mitmevärviline
roz	ružičast	ružičast	roza	розов	rausvas	rozā	roosa
crom satin	satēnasti hrom	satēnasti krom	satēnast krom	сатенен-хром	atlaso chrominė	satīna hroms	satīin-kroom
transparent	providan	proziran	prozorno	прозрачен	skaidri	caurspīdīgs	lābipaistev
alb	belo	bijelo	belo	бял	balta	balts	valge

CONTENTS • TARTALOMJEGYZÉK • INHALTSVERZEICHNIS

Art. number	Name	Page
Cikkszám	Név	Oldal
Art. nummer	Name	Seite

Art. number	Name	Page
Cikkszám	Név	Oldal
Art. nummer	Name	Seite

Art. number	Name	Page
Cikkszám	Név	Oldal
Art. nummer	Name	Seite

Art. number	Name	Page
Cikkszám	Név	Oldal
Art. nummer	Name	Seite

71049	Sindri	14
71050	Sindri	14
71051	Sindri	14
71052	Jarnelle	11
71087	Sindri	15
71088	Jarnelle	10
71248	Revan	35
71285	Gello	41
71286	Gello	41
71287	Holize	24
71288	Holize	24
71289	Dewson	25
71290	Mathiola	24
71291	Mathiola	24
71293	Azome	37
71294	Meduza	31
71295	Looplab	36
71296	Emilion	21

71297	Formand	19
71298	Aslov	29
71299	Aslov	29
71300	Aslov	28
71301	Sarabi	30
71302	Isaure	20
71309	Thric	22
71310	Thric	22
71311	Thrac	23
71312	Thrac	23
72150	Revan	35
72191	Montema	16
72194	Meduza	31
72221	Thric	22
72222	Thrac	23
72223	Thrac	23
72229	Sindri	12
72231	Sindri	12

72233	Jarnelle	11
72234	Elvio	9
72251	Narmin	34
72263	Rovier	33
72264	Rovier	33
72296	Emilion	21
72297	Formand	19
72298	Aslov	28
72299	Lition	32
72300	Lition	32
72301	Isaure	20
72302	Isaure	20
72303	Rosehip	27
72304	Rosehip	27
74194	Sindri	15
74195	Sindri	15
74196	Jarnelle	10
74197	Jarnelle	10

74209	Tipy	44
74212	Revan	35
74213	Traze	42
74214	Zavier	44
74232	Cerie	42
74233	Cerie	42
74234	Bedi	43
74235	Bedi	43
74236	Bedi	43
74237	Bedi	43
74238	Tafi	43
74240	Narmin	34
74241	Narmin	34
75021	Colzar	39
75022	Colzar	39
76022	Cubiko	45
76023	Jocker	45

IMPRINT • IMPRESSZUM • IMPRESSUM

English

Colour and pattern discrepancy are possible. We are entitled to change the pattern.
We don't bear the responsibility of the printing failure.

Magyar

Szín és minta eltérés lehetséges. A minta változtatás jogát fenntartjuk!
Az esetleges nyomdai hibákért elnézésüket kérjük és azokért felelősséget nem vállalunk.

Deutsch

Farbe und Musterunterschied ist möglich. Wir halten das Recht von Musteränderung aufrecht.
Vor die eventuellen Druckfehler bitten wir um Entschuldigung und vor die Fehler können wir die Verantwortung nicht übernehmen.

Grafikai munkák: Visionext Reklámstúdió
Nyomdai munkák: Keskeny és Társai 2001 Kft.



www.rabalux.com